

NEMA L5-20P

VIEW A

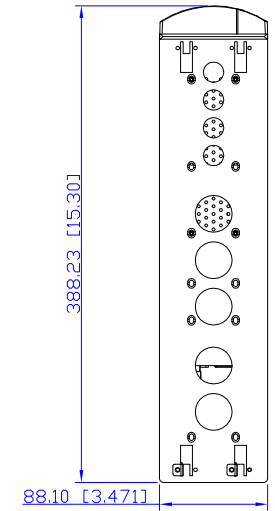

VIEW B

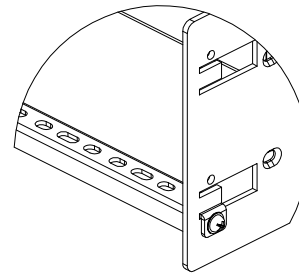
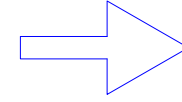
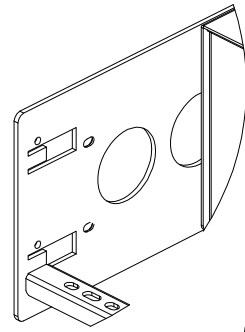
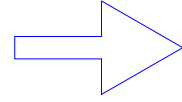
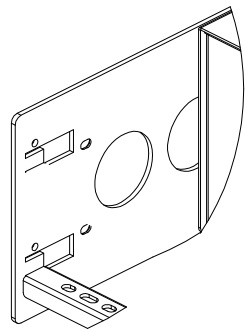
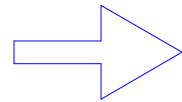
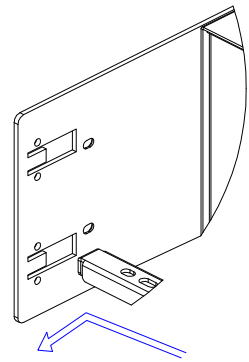
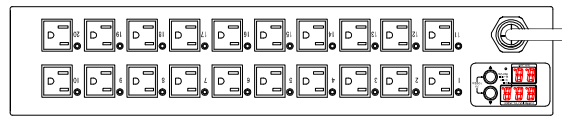

NEMA L5-20P

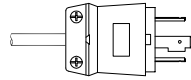

See VIEW A

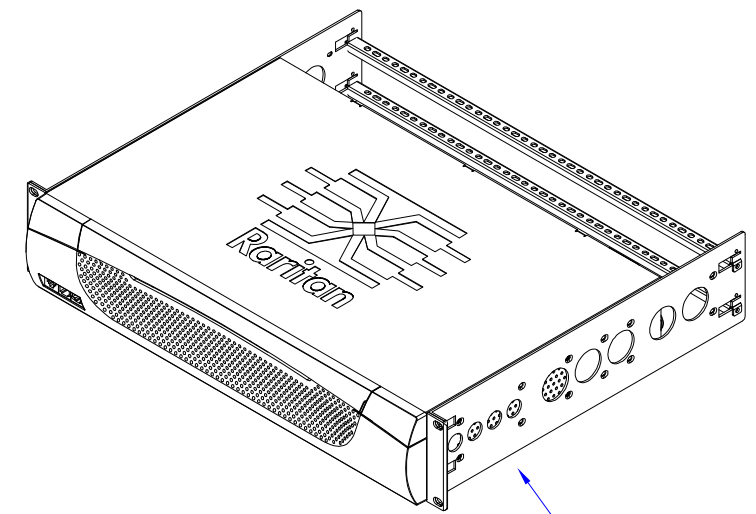
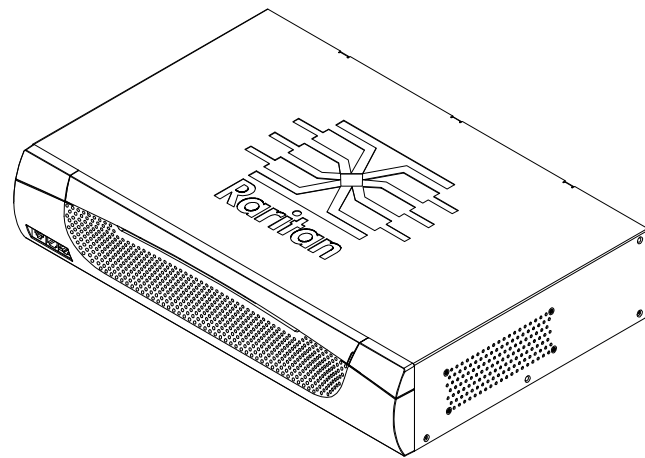
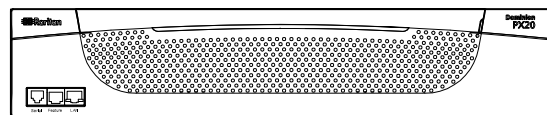
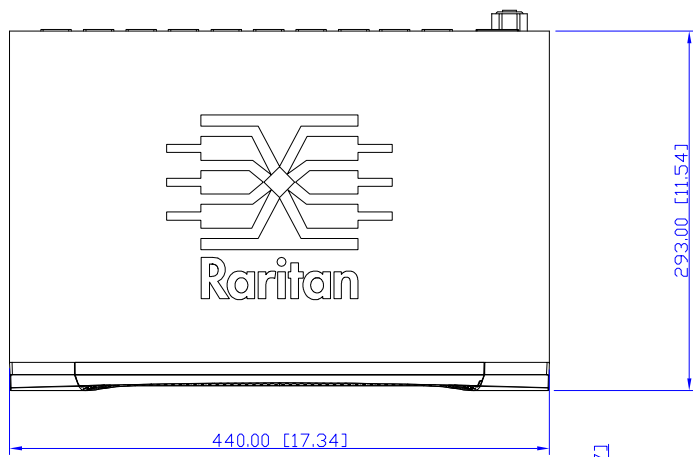

See VIEW B

NOTES:

1. ALL DIMENSIONS ARE MILLIMETERS [INCHES].



DRAWN : Eva	Sep 24, 2009
ENGINEER: Sam	Sep 24, 2009
APPROVED: Kevin_C	Sep 24, 2009



PROJECTION
THIRD ANGLE

DO NOT SCALE DRAWING

SHEET 1 OF 1

THIS DRAWING AND SPECIFICATIONS HEREIN ARE THE PROPERTY OF RARITAN, INC. AND SHALL NOT BE COPIED, REPRODUCED OR USED, IN WHOLE OR IN PART, AS THE BASIS FOR THE MANUFACTURE OR SALE OF ITEMS WITHOUT WRITTEN PERMISSION FROM RARITAN, INC. THIS DRAWING IS BASED UPON LATEST AVAILABLE INFORMATION AND IS SUBJECT TO CHANGE WITHOUT NOTICE.

TITLE: iPDU Zero U,
Single Phase, 16A/100-120V,
Input: NEMA L5-20P,
Output: (20) NEMA 5-15

DWG NO. DPXR20-20L & DPXR20-20L-M	REV. A
--------------------------------------	-----------