

NEMA L21-20P

VIEW A

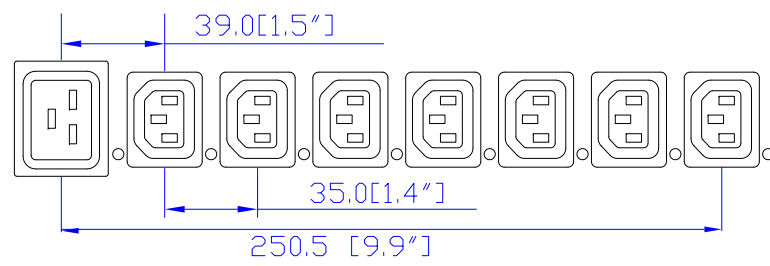

VIEW B

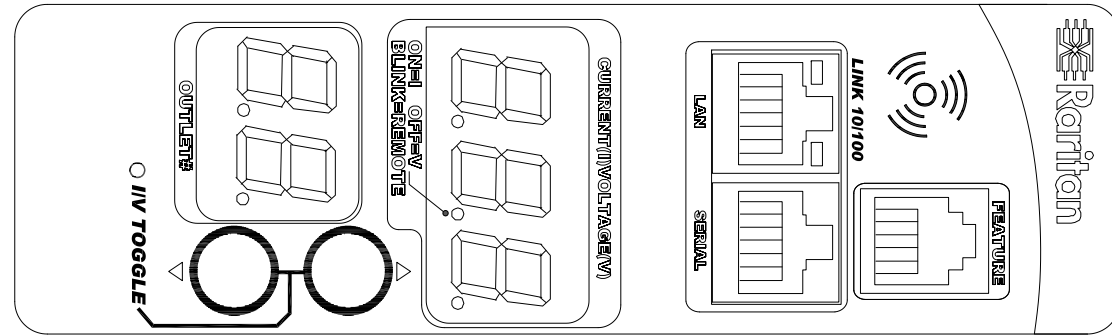

VIEW C

Option 1.

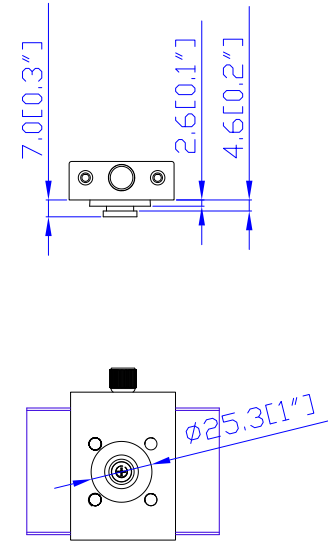

Option 2.

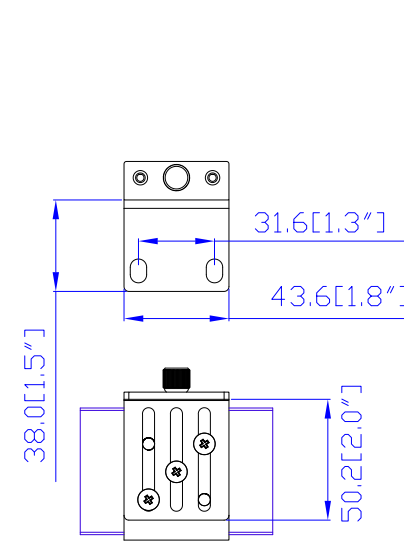

Option 3.

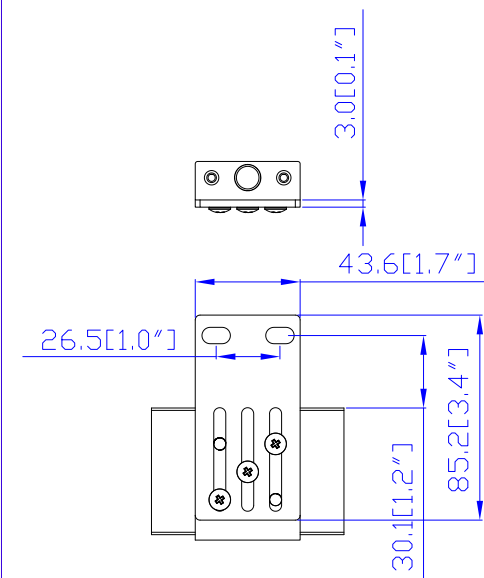

VIEW D

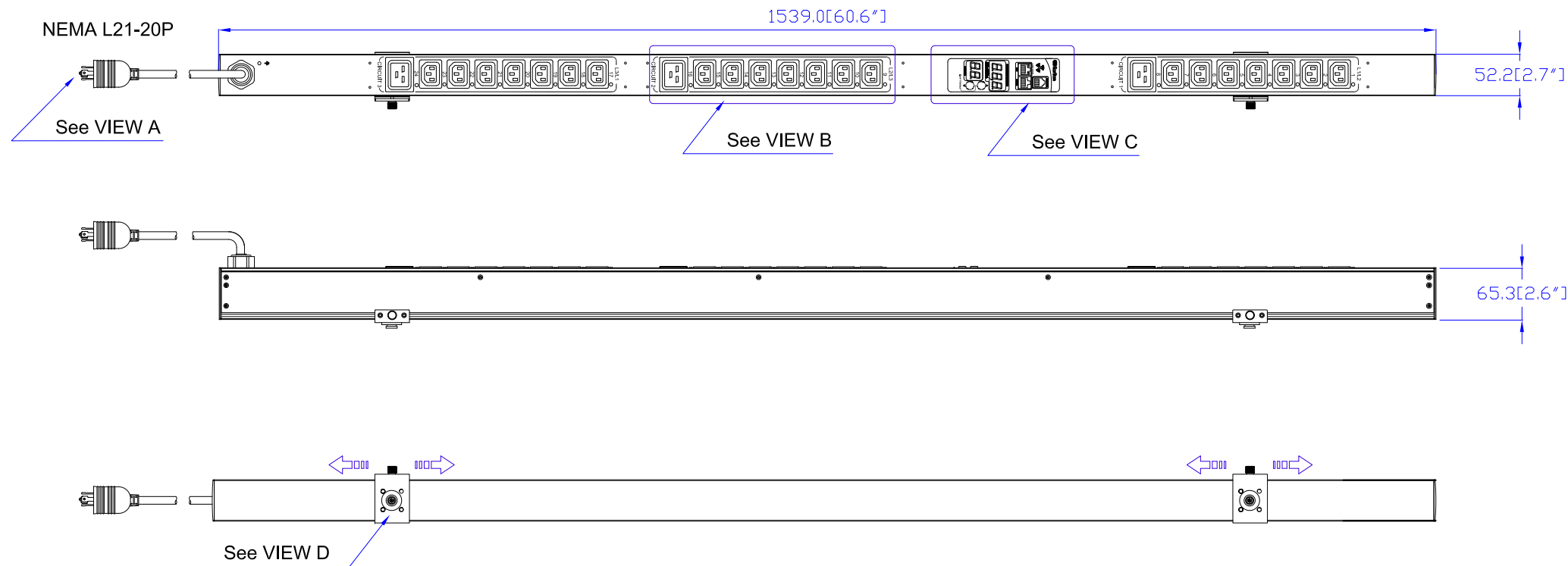

NOTES:
1. ALL DIMENSIONS ARE MILLIMETERS [INCHES].

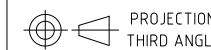

DO NOT SCALE DRAWING
SHEET 1 OF 1

THIS DRAWING AND SPECIFICATIONS HEREIN ARE THE PROPERTY OF RARITAN, INC. AND SHALL NOT BE COPIED, REPRODUCED OR USED, IN WHOLE OR IN PART, AS THE BASIS FOR THE MANUFACTURE OR SALE OF ITEMS WITHOUT WRITTEN PERMISSION FROM RARITAN, INC. THIS DRAWING IS BASED UPON LATEST AVAILABLE INFORMATION AND IS SUBJECT TO CHANGE WITHOUT NOTICE.

DRAWN : EVA Lin	Mar. 04, 210
ENGINEER: Kevin_L	Mar. 04, 210
APPROVED: Kevin_C	Mar. 04, 210

TITLE: iPDU Zero U,
Three Phase, 16A/190-208V,
Input: NEMA L21-20P
Output(24) IEC320 C13

DWG NO. **MPX-5510 & MPX-4510** REV. **A**